

SLIDING DOOR 35 dB

Soundproof sliding door with aluminium profiles



35 dB sliding door is a door solution with aluminium profiles and sound-resistant glass. The sliding door can be fitted in a separate doorway or joined with fixed partition modules. The door leaf's slide has stoppers for fixing it in the open and closed position.

OPENING DIMENSIONS

Height 2110 mm / width 1000 mm

SOUND RESISTANCE

Rw 35 dB (VTT test report No. VTT-S-02286-17)

MATERIAL

Aluminium profiles + sound-resistant laminated safety glass

FINISH

Natural anodising or RAL paint

SEALING STRIPS

Clear (glass), Black (doorway)

SLIDE SYSTEM

Top slide with floor guide

LOCKING

No lock or ABLOY LC306

HANDLE

Arched handle 200 mm, Brushed RST

THRESHOLD

40 x 3 mm aluminium
+ black brush seal in the bottom edge of the door leaf

WEIGHT





25 kg / m²

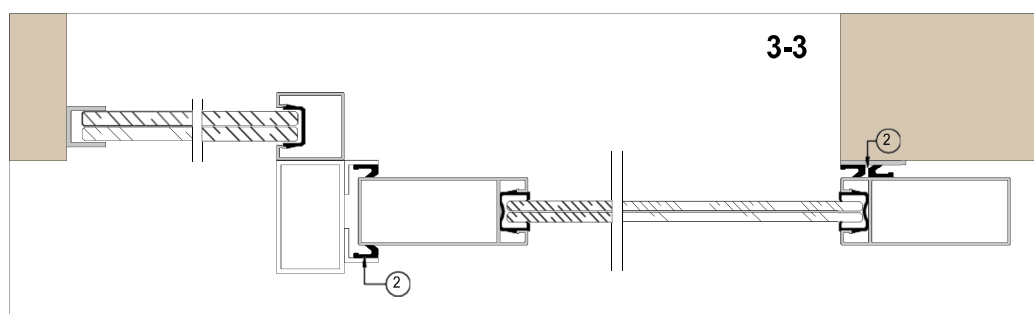
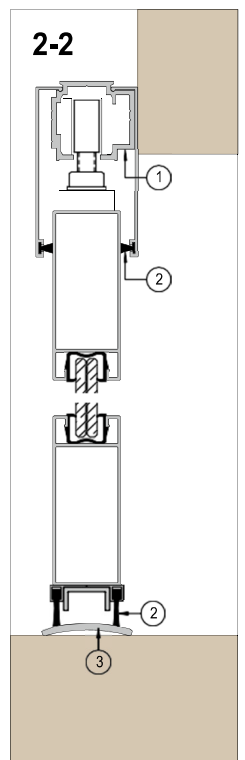
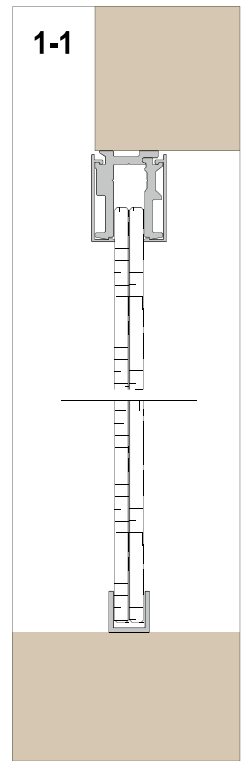
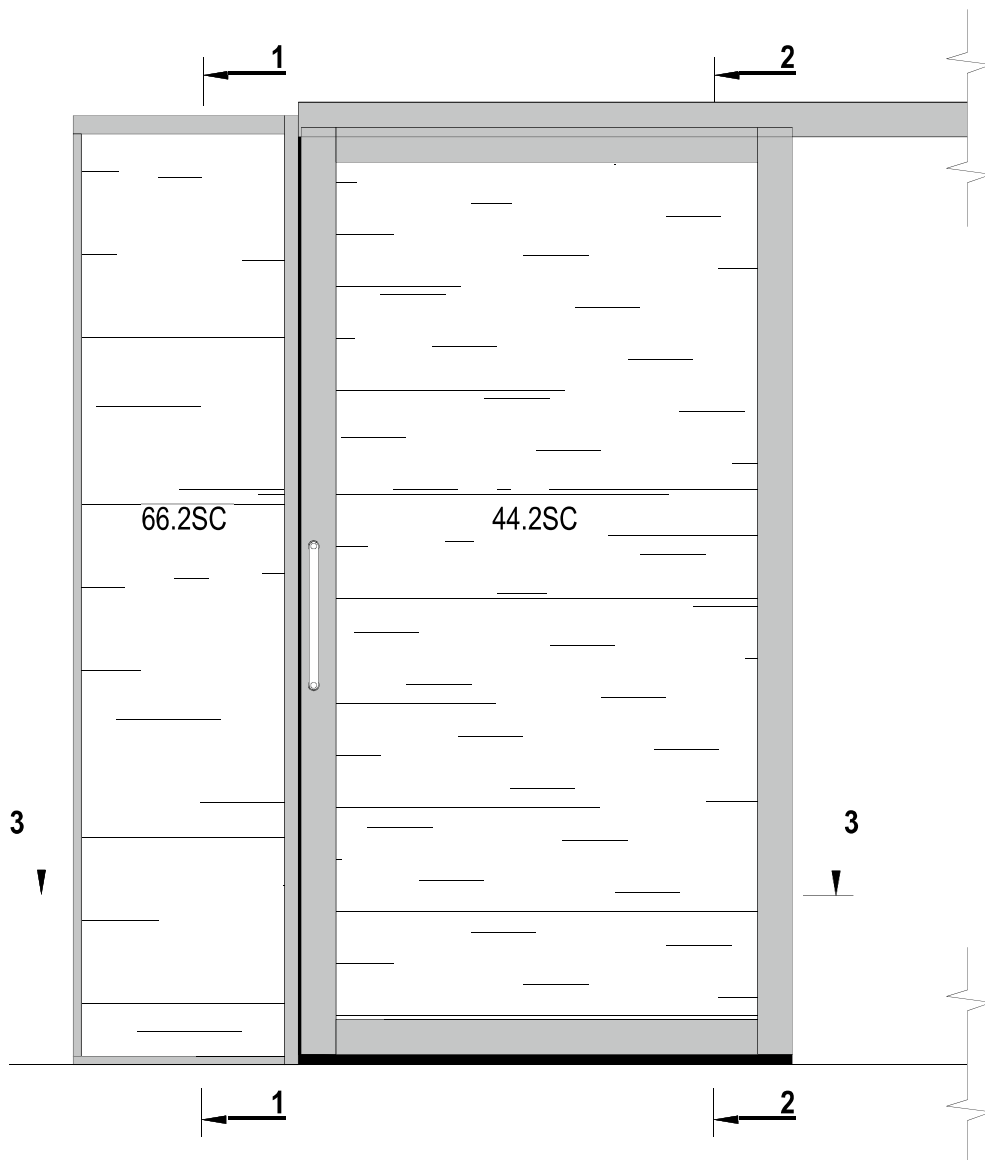

EXTRAS

Glass film / soft-close stopper



Type: MOD92
 Sliding door
 material: Aluminium
 Glass: Door 44.2 SC
 Wall 66.2 SC

-  Aluminium profile
-  Sealing strips
-  Wall
-  Glass

-  1 Top slide
-  2 Sealing strip
-  3 Threshold ~ 40 x 5 mm